

# STOCK Moulding Collection



**Holmes Lumber**   
*The Lumberyard For Professionals*

## In-Stock Moulding Collection

Note: Stock can vary by location.

contents

Sales Policies ..... 1

Numbering Code .. 1

**S4S Stock**.....2

### Hardwood Moulding

Casing.....3

Backband .....6

Base .....7

Base Cap.....9

Shoe Mould ..... 10

Quarter Round ..... 10

Outside Corner ..... 10

Cove ..... 10

Staff Mould..... 10

Crown..... 11

Crown Inserts..... 16

Dentil Mould ..... 16

Rosette ..... 17

Landing Tread..... 17

Base Blocks..... 18

Door Stop..... 19

Glass Bead..... 19

Lattice ..... 19

Door Jamb ..... 19

Chair Rail.....20

Nosing .....21

Half Round.....21

Panel Mould .....22

T&G Beadboard .....22

Planking .....22

Bed Mould .....23

Mullions .....23

Cabinet Mould.....23

Screen Bead .....23

Window Sill.....24

### Solid Pine

Astragal.....25

Base .....25

Brick Mould .....25

Chair Rail.....25

Casing.....25

Corner Guard.....26

Cove .....26

Crown.....26

Lattice .....26

Full Round.....26

Parting Stop.....27

Quarter Round .....27

Screen Mould.....27

Shoe .....27

Stop.....27

Wall/Hand Rail.....27

### Primed Finger-Joint

Base .....28

Casing.....29

Brick Mould .....29

Chair Rail.....29

Crown.....30

Stop.....30

Shoe .....30

Base Cap.....30

### Medium Density Fiberboard (MDF)

Base .....31

Eased Edge S4S .....32

Casing.....33

Crown.....35

Chair Rail.....38

T&G Ship Lap .....38

### Embossed Oak

Casing.....39

Base .....39

Shoe .....39

Jamb.....39

Stop.....39

## MISSION STATEMENT

We are committed to:

1. Providing professional builders and consumers with high quality lumber and building materials at a superior level of customer service and product expertise.
2. Providing value-added services to our customers to increase their and our success and profitability.
3. Constant evaluation and improvement of the way we conduct our business.
4. The application of evolving technology and methods to the customer/lumberyard relationship.
5. Exercising honesty, courtesy, and integrity in all relations with customers, co-workers, suppliers, and competitors.
6. A caring and supportive environment providing opportunity for personal growth, fulfillment, recognition of accomplishment, security, and contribution.

# Holmes Lumber Company

## Sales Policies

**SERVICE:** The management and staff of Holmes Lumber Company recognizes that our success depends upon the success and satisfaction of you, our customers. We strive to supply you with the best in both products and services.

**PRICING:** Prices and quotes are available from any of our professional sales team members. Please note that prices are subject to change.

**ORDERS:** Orders may be placed in person, by phone, fax, or e-mail. Verify your order with a Holmes Lumber Salesman.

**SPECIAL ORDERS:** If the knife is made—allow **5 full business days** lead time. If knife is not made—allow **8 full business days** lead time. Returns are subject to no credit.

**RETURNS:** Returns may be subject to a 15% restocking charge. Exceptions are errors by Holmes Lumber Company or if the quality of the product is defective as affirmed by Holmes Lumber or our vender.

**SHIPPING:** We have our own trim specific delivery fleet to ensure that your items arrive in quality condition. Please be in contact with your salesman to schedule delivery date and time.

Prefinishing available on request. Allow additional time for all prefinished jobs.

### PRICING NOTES:

- Add 20% for specified lengths.

### CUSTOM PROFILES:

- Add \$35.00 minimum order charge to custom profile quantities less than 200'.
- Custom knife charge—\$50.00 per inch.

## Numbering Code

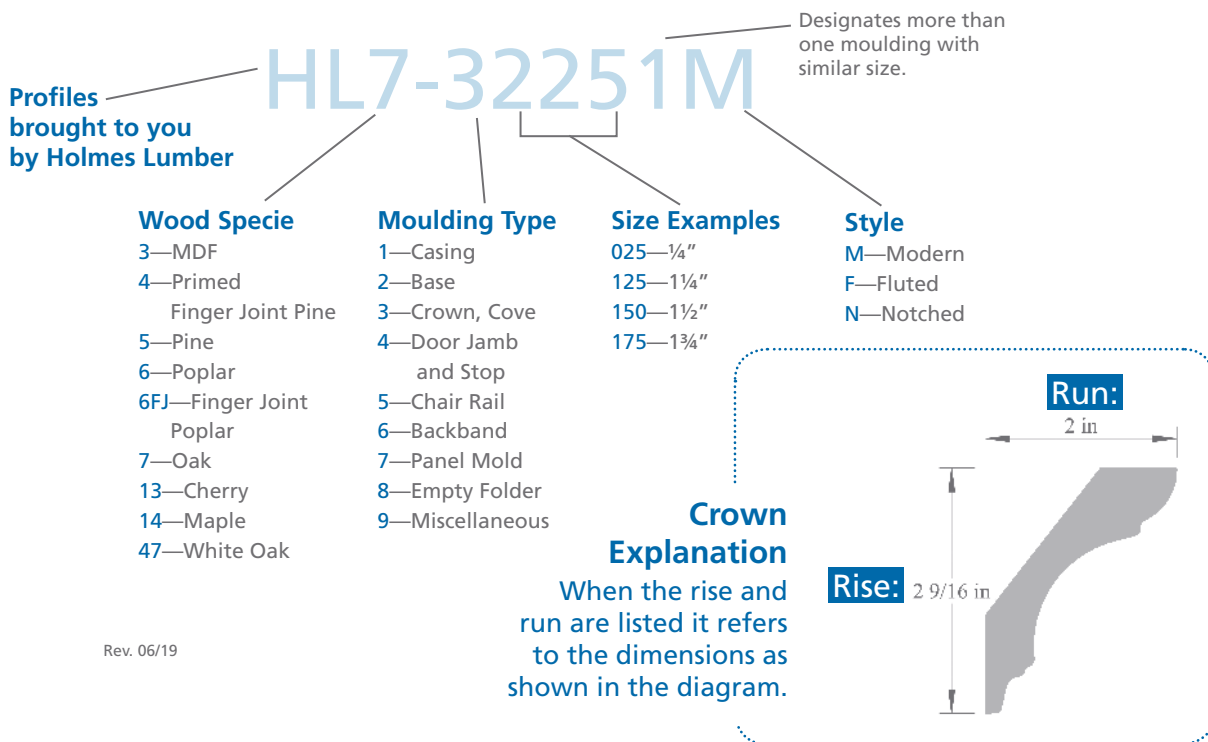

# S4S STOCK

## OAK

$\frac{3}{4}$ " x  $1\frac{5}{8}$ "  
 $\frac{3}{4}$ " x 2"  
 $\frac{3}{4}$ " x  $2\frac{1}{2}$ "  
 $\frac{3}{4}$ " x  $3\frac{1}{2}$ "  
 $\frac{3}{4}$ " x  $5\frac{1}{2}$ "  
 $\frac{3}{4}$ " x  $7\frac{1}{4}$ "  
 $\frac{3}{4}$ " x  $9\frac{1}{4}$ "  
 $\frac{3}{4}$ " x  $9\frac{1}{4}$ " x 14'  
 $\frac{3}{4}$ " x  $9\frac{1}{4}$ " x 15'  
 $\frac{3}{4}$ " x  $9\frac{1}{4}$ " x 16'  
 $\frac{3}{4}$ " x  $11\frac{1}{4}$ "  
 $\frac{3}{4}$ " x  $11\frac{1}{4}$ " x 14'  
 $\frac{3}{4}$ " x  $11\frac{1}{4}$ " x 15'  
 $\frac{3}{4}$ " x  $11\frac{1}{4}$ " x 16'  
1" x  $3\frac{1}{2}$ "  
1" x  $5\frac{1}{2}$ "  
1" x  $7\frac{1}{4}$ "  
1" x  $11\frac{1}{4}$ "

## CHERRY

(12' and shorter)\*

$\frac{3}{4}$ " x  $1\frac{5}{8}$ "  
 $\frac{3}{4}$ " x  $2\frac{1}{2}$ "  
 $\frac{3}{4}$ " x  $3\frac{1}{2}$ "  
 $\frac{3}{4}$ " x  $5\frac{1}{2}$ "  
 $\frac{3}{4}$ " x  $7\frac{1}{4}$ "

## POPLAR

$\frac{3}{4}$ " x  $1\frac{5}{8}$ "  
 $\frac{3}{4}$ " x 2"  
 $\frac{3}{4}$ " x  $2\frac{1}{2}$ "  
 $\frac{3}{4}$ " x  $3\frac{1}{2}$ "  
 $\frac{3}{4}$ " x  $5\frac{1}{2}$ "  
 $\frac{3}{4}$ " x  $7\frac{1}{4}$ "  
 $\frac{3}{4}$ " x  $9\frac{1}{4}$ "  
 $\frac{3}{4}$ " x  $9\frac{1}{4}$ " x 14'  
 $\frac{3}{4}$ " x  $9\frac{1}{4}$ " x 15'  
 $\frac{3}{4}$ " x  $9\frac{1}{4}$ " x 16'  
 $\frac{3}{4}$ " x  $11\frac{1}{4}$ "  
 $\frac{3}{4}$ " x  $11\frac{1}{4}$ " x 14'  
 $\frac{3}{4}$ " x  $11\frac{1}{4}$ " x 15'  
 $\frac{3}{4}$ " x  $11\frac{1}{4}$ " x 16'  
1" x  $3\frac{1}{2}$ "  
1" x  $5\frac{1}{2}$ "  
1" x  $7\frac{1}{4}$ "  
1" x  $9\frac{1}{4}$ "  
1" x  $11\frac{1}{4}$ "

## FJ POPLAR

$\frac{3}{4}$ " x  $1\frac{1}{2}$ "  
 $\frac{3}{4}$ " x  $3\frac{1}{2}$ "  
 $\frac{3}{4}$ " x  $5\frac{1}{2}$ "  
 $\frac{3}{4}$ " x  $7\frac{1}{4}$ "  
 $\frac{3}{4}$ " x  $9\frac{1}{4}$ "  
 $\frac{3}{4}$ " x  $11\frac{1}{4}$ "

## MAPLE (12' and shorter)\*

$\frac{3}{4}$ " x  $1\frac{5}{8}$ "  
 $\frac{3}{4}$ " x  $2\frac{1}{2}$ "  
 $\frac{3}{4}$ " x  $3\frac{1}{2}$ "  
 $\frac{3}{4}$ " x  $5\frac{1}{2}$ "  
 $\frac{3}{4}$ " x  $7\frac{1}{4}$ "

## BIRCH (12' and shorter)\*

$\frac{3}{4}$ " x  $1\frac{5}{8}$ "  
 $\frac{3}{4}$ " x  $2\frac{1}{2}$ "  
 $\frac{3}{4}$ " x  $3\frac{1}{2}$ "  
 $\frac{3}{4}$ " x  $5\frac{1}{2}$ "  
 $\frac{3}{4}$ " x  $7\frac{1}{4}$ "

## PFJ (PRIME FINGER JOINT) PINE

$\frac{11}{16}$ " x  $1\frac{3}{4}$ "  
 $\frac{11}{16}$ " x  $3\frac{1}{2}$ "  
 $\frac{11}{16}$ " x  $5\frac{1}{2}$ "  
 $\frac{11}{16}$ " x  $7\frac{1}{4}$ "

## RADIATA PINE

$\frac{3}{4}$ " x  $3\frac{1}{2}$ "  
 $\frac{3}{4}$ " x  $5\frac{1}{2}$ "  
 $\frac{3}{4}$ " x  $7\frac{1}{4}$ "  
 $\frac{3}{4}$ " x  $11\frac{1}{4}$ "

## MDF

$\frac{11}{16}$ " x  $3\frac{1}{2}$ "  
 $\frac{11}{16}$ " x  $5\frac{1}{2}$ "  
 $\frac{11}{16}$ " x  $7\frac{1}{4}$ "  
 $\frac{11}{16}$ " x  $9\frac{1}{4}$ "  
 $\frac{11}{16}$ " x  $11\frac{1}{4}$ "

\*Cherry, Maple, and Birch longer lengths subject to availability. Up-charge applies.

# CASING



HL1225  $\frac{9}{16}$ " x  $2\frac{1}{4}$ " **RED OAK AND POPLAR**



HL1225M  $\frac{9}{16}$ " x  $2\frac{1}{4}$ " **RED OAK AND POPLAR**



HL122511  $\frac{3}{4}$ " x  $2\frac{1}{4}$ " **POPLAR AND FJ POPLAR**



HL1250  $\frac{3}{4}$ " x  $2\frac{1}{2}$ " **RED OAK AND POPLAR**



HL1275  $\frac{3}{4}$ " x  $2\frac{3}{4}$ " **RED OAK, POPLAR, AND FJ POPLAR**



HL12751  $\frac{9}{16}$ " x  $2\frac{3}{4}$ " **RED OAK AND POPLAR**

## CASING

HL752  $\frac{3}{4}$ " x  $2\frac{3}{4}$ " **RED OAK AND POPLAR**HL130029  $\frac{3}{4}$ " x 3" **POPLAR AND FJ POPLAR**HL13251  $\frac{3}{4}$ " x  $3\frac{1}{4}$ " **RED OAK AND POPLAR**HL13254  $\frac{3}{4}$ " x  $3\frac{1}{4}$ " **RED OAK AND POPLAR**HL1350  $\frac{3}{4}$ " x  $3\frac{1}{2}$ " **RED OAK, POPLAR, AND FJ POPLAR**HL13501  $\frac{3}{4}$ " x  $3\frac{1}{2}$ " **RED OAK AND POPLAR**

# CASING



HL13503  $\frac{3}{4}$ " x  $3\frac{1}{2}$ " **RED OAK AND POPLAR**



HL13504 1" x  $3\frac{1}{2}$ " **RED OAK AND POPLAR**



HL135014  $\frac{3}{4}$ " x  $3\frac{1}{2}$ " **RED OAK AND POPLAR**



HL135022  $\frac{3}{4}$ " x  $3\frac{1}{2}$ " **POPLAR AND FJ POPLAR**



HL135095  $\frac{13}{16}$ " x  $3\frac{1}{2}$ " **POPLAR AND FJ POPLAR**

## CASING



HL140022 1 1/4" x 4" POPLAR



HL1350F 3/4" x 3 1/2" RED OAK AND POPLAR



HL1550F 3/4" x 5 1/2" POPLAR

## BACKBAND



HL61251  
3/4" x 1 1/4"  
RED OAK  
AND POPLAR



HL6150  
1 3/16" x 1 1/2"  
RED OAK AND  
POPLAR



HL61383  
1 1/2" x 1 3/8"  
POPLAR



HL61252  
3/4" x 1 1/4"  
RED OAK  
AND POPLAR



HL613813  
7/8" x 1 3/8"  
POPLAR



HL61381  
1 3/4" x 1 3/8"  
RED OAK  
AND POPLAR



# BASE



HL2300 7/16" x 3" **RED OAK AND POPLAR**



HL2300M 7/16" x 3" **RED OAK AND POPLAR**



HL2350 5/8" x 3 1/2" **RED OAK AND POPLAR**



HL235011 1 1/16" x 3 1/2" **POPLAR**



HL2400 7/16" x 4" **RED OAK AND POPLAR**



HL24001 7/16" x 4" **RED OAK AND POPLAR**



## BASE



- HL232510  $\frac{5}{8}$ " x  $3\frac{1}{4}$ " **POPLAR AND FJ POPLAR**  
 HL24255  $\frac{5}{8}$ " x  $4\frac{1}{4}$ " **POPLAR AND FJ POPLAR**  
 HL252510  $\frac{5}{8}$ " x  $5\frac{1}{4}$ " **POPLAR AND FJ POPLAR (shown)**



- HL23259  $\frac{5}{8}$ " x  $3\frac{1}{4}$ " **POPLAR AND FJ POPLAR**  
 HL24254  $\frac{5}{8}$ " x  $4\frac{1}{4}$ " **POPLAR AND FJ POPLAR (matches MDF 20136CBM)**  
 HL252513  $\frac{5}{8}$ " x  $5\frac{1}{4}$ " **POPLAR AND FJ POPLAR (shown)**  
 HL26252  $\frac{5}{8}$ " x  $6\frac{1}{4}$ " **POPLAR AND FJ POPLAR**  
 HL272516  $\frac{5}{8}$ " x  $7\frac{1}{4}$ " **POPLAR AND FJ POPLAR**



- HL2500  $\frac{9}{16}$ " x 5" **POPLAR**



- HL252516  $\frac{9}{16}$ " x  $5\frac{1}{4}$ " **POPLAR (matches MDF 163EM)**



- HL24501  $1\frac{1}{16}$ " x  $4\frac{1}{2}$ " **RED OAK AND POPLAR**  
 HL2550  $1\frac{1}{16}$ " x  $5\frac{1}{2}$ " **RED OAK AND POPLAR (shown)**



- HL2450  $1\frac{1}{16}$ " x  $4\frac{1}{2}$ " **RED OAK AND POPLAR**  
 HL25502  $1\frac{1}{16}$ " x  $5\frac{1}{2}$ " **RED OAK, POPLAR, AND FJ POPLAR (shown)**

# BASE



HL24505  $1\frac{1}{16}''$  x  $4\frac{1}{2}''$  **RED OAK, POPLAR, AND FJ POPLAR**  
 HL25505  $1\frac{1}{16}''$  x  $5\frac{1}{2}''$  **RED OAK, POPLAR, AND FJ POPLAR (shown)**



HL25503  $1\frac{1}{16}''$  x  $5\frac{1}{2}''$  **RED OAK, POPLAR, AND FJ POPLAR**

# BASE CAP



HL2100  
 $1\frac{1}{16}''$  x 1"  
**RED OAK AND POPLAR**



HL21381  
 $\frac{3}{4}''$  x  $1\frac{3}{8}''$   
**RED OAK AND POPLAR**



HL21388  
 $\frac{9}{16}''$  x  $1\frac{3}{8}''$   
**POPLAR**



HL21442  
 $\frac{9}{16}''$  x  $1\frac{7}{16}''$   
**POPLAR**



HL2175  
 $\frac{5}{8}''$  x  $1\frac{3}{4}''$   
**RED OAK AND POPLAR**



HL21751  
 $\frac{5}{8}''$  x  $1\frac{5}{8}''$   
**RED OAK AND POPLAR**



HL21757  
 $1\frac{3}{16}''$  x  $1\frac{3}{4}''$   
**POPLAR**



HL2125  
 $\frac{3}{4}''$  x  $1\frac{1}{4}''$   
**RED OAK AND POPLAR**

### SHOE MOULD



HL2050  
3/4" x 1/2"

RED OAK,  
WHITE OAK,  
POPLAR,  
HARD MAPLE

### QUARTER ROUND



HL2075  
3/4" x 3/4"

RED OAK  
AND POPLAR

### OUTSIDE CORNER



HL9106  
1 1/16" x 1 1/16"

RED OAK  
AND POPLAR



HL9075  
3/4" x 3/4"

RED OAK  
AND POPLAR

### COVE



HL3050  
1/2" x 1/2"

RED OAK  
AND POPLAR



HL3075  
3/4" x 3/4"

RED OAK,  
WHITE OAK,  
POPLAR AND  
FLEX

### STAFF MOULD



HL70751  
5/8" x 7/8"

RED OAK  
AND POPLAR

# CROWN



HL3175  $\frac{3}{4}$ " x  $1\frac{3}{4}$ "  
**RED OAK AND POPLAR**  
Rise: 1-1/4" Run: 1-5/16"



HL317513  $\frac{3}{4}$ " x  $1\frac{3}{4}$ "  
**POPLAR**  
Rise: 1-5/16" Run: 1-1/8"



HL3225  $\frac{5}{8}$ " x  $2\frac{1}{4}$ "  
**RED OAK AND POPLAR**  
Rise: 1-13/16" Run: 1-7/16"



HL3325  $\frac{3}{4}$ " x  $3\frac{1}{4}$ "  
**RED OAK AND POPLAR**  
Rise: 2-9/16" Run: 2-1/16"



HL3363  $\frac{3}{4}$ " x  $3\frac{5}{8}$ "  
**RED OAK AND POPLAR**  
Rise: 2-7/8" Run: 2-1/4"

# CROWN

HL3625 7/8" x 6 1/4"  
**RED OAK AND POPLAR**  
 Rise: 5"  
 Run: 3-13/16"

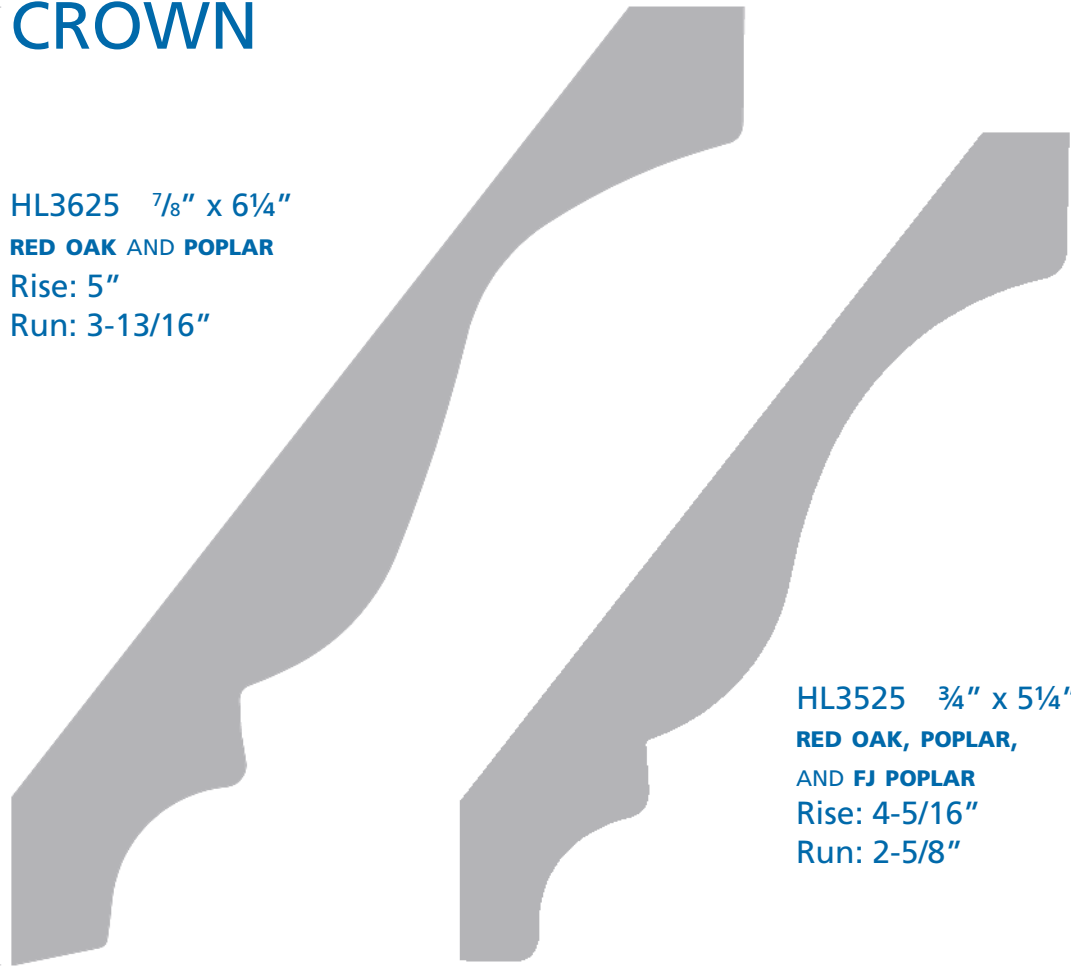

HL3525 3/4" x 5 1/4"  
**RED OAK, POPLAR,  
 AND FJ POPLAR**  
 Rise: 4-5/16"  
 Run: 2-5/8"

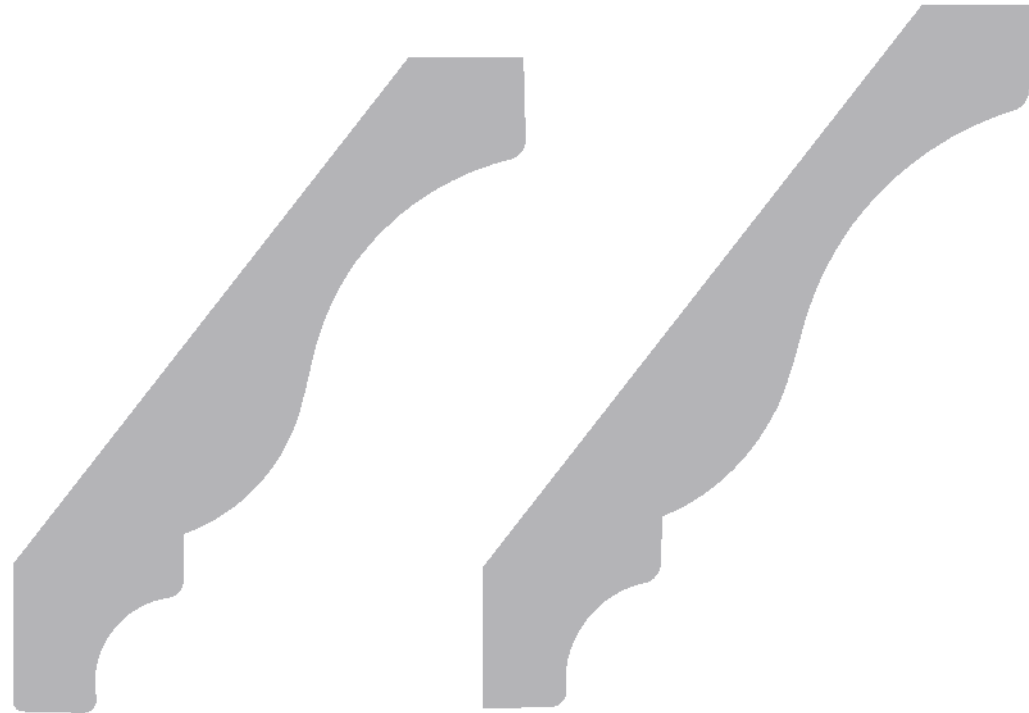

HL3425 3/4" x 4 1/4"  
**RED OAK,  
 POPLAR AND FJ POPLAR**  
 Rise: 3-3/8" Run: 2-5/8"

HL3463 1 1/16" x 4 5/8"  
 (Similar to WM 47)  
**RED OAK AND POPLAR**  
 Rise: 3-11/16" Run: 2-7/8"

# CROWN



HL33635  $7/16''$  x  $3^{5/8}''$   
**POPLAR**  
Rise:  $2-9/16''$  Run:  $2-9/16''$



HL33251  $3/4''$  x  $3^{1/4}''$   
**RED OAK AND POPLAR**  
Rise:  $2-9/16''$  Run:  $2''$



HL34251  $3/4''$  x  $4^{1/4}''$   
**RED OAK AND POPLAR**  
Rise:  $2-13/16''$  Run:  $3-1/4''$



HL3532  $1^{1/16}''$  x  $5^{3/8}''$   
**POPLAR**  
Rise:  $4''$  Run:  $3-1/2''$

# CROWN



HL342511 3/4" x 4 1/4"  
**POPLAR**  
Rise: 3-1/4" Run: 2-11/16"



HL332513 3/4" x 3 1/4"  
**POPLAR**  
Rise: 2-1/2"  
Run: 2-1/16"



HL352518 3/4" x 5 1/4"  
**POPLAR**  
Rise: 4" Run: 3-3/8"



# CROWN



HL342510 3/4" x 4 1/4"  
**POPLAR AND FJ POPLAR**  
Rise: 2-13/16" Run: 3-3/16"



HL332512 3/4" x 3 1/4"  
**POPLAR AND FJ POPLAR**  
Rise: 2-1/4" Run: 2-3/8"



HL352517 3/4" x 5 1/4"  
**POPLAR AND FJ POPLAR**  
Rise: 3-9/16" Run: 3-7/8"

## CROWN INSERTS

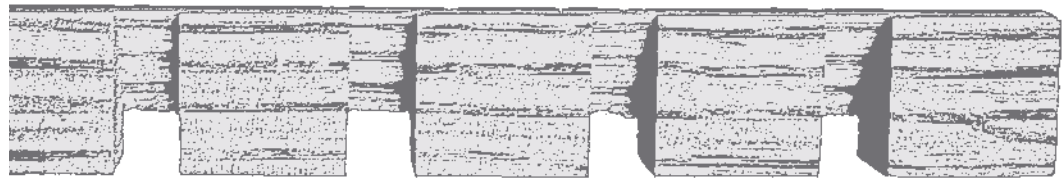

HL3063 1/2" x 5/8" • RED OAK AND POPLAR

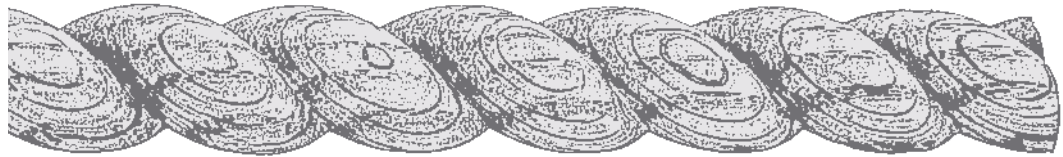

HL30751 3/4" • RED OAK AND POPLAR

## DENTIL MOULD

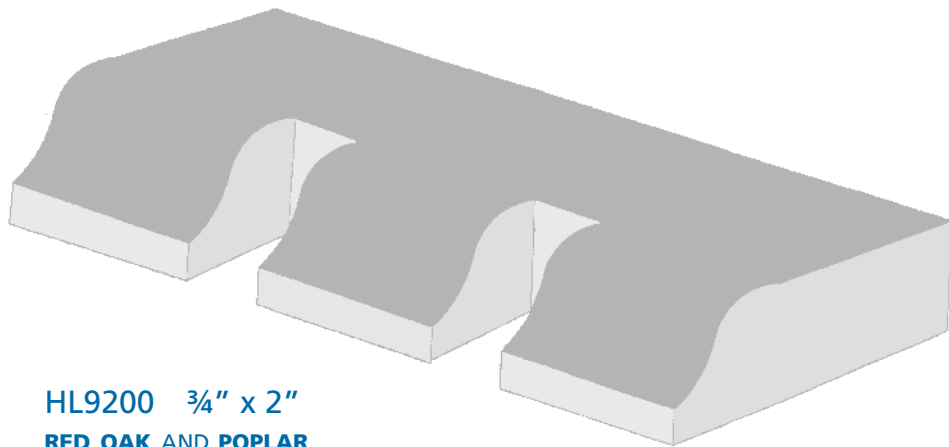

HL9200 3/4" x 2"  
RED OAK AND POPLAR

# ROSETTE

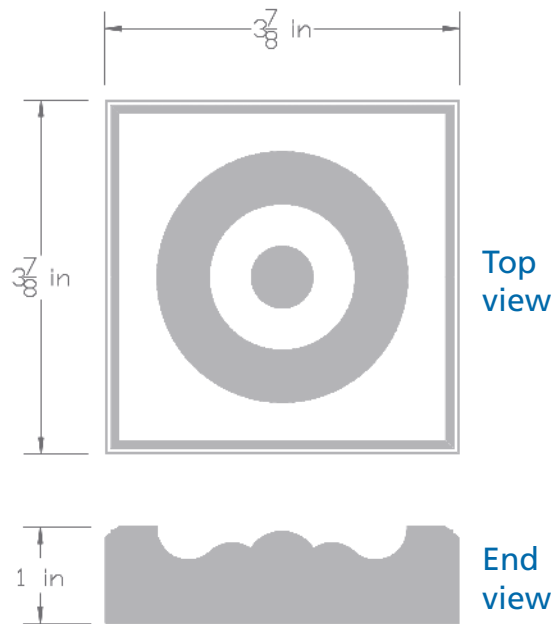

HL1263	3/4" x 2 5/8" x 2 5/8"	<b>RED OAK AND POPLAR</b>
HL1313	1" x 3 1/8" x 3 1/8"	<b>RED OAK AND POPLAR</b>
HL1388	1" x 3 7/8" x 3 7/8"	<b>RED OAK AND POPLAR</b>

- Custom sizes available for these items.
- Items in this section have been resized to fit page format.

# LANDING TREAD



HL8090	1 1/16" x 3 1/2"	<b>RED OAK AND POPLAR</b>
HL8090-5	1 1/16" x 5 1/2"	<b>RED OAK, WHITE OAK AND POPLAR</b>
HL8090-7	1 1/16" x 7 1/4"	<b>RED OAK, WHITE OAK AND POPLAR</b>

# BASE BLOCKS

**HL2388**  
 1" x 3<sup>7</sup>/<sub>8</sub>" x 9"  
**RED OAK AND POPLAR**

**HL2313**  
 1" x 3<sup>1</sup>/<sub>8</sub>" x 6"  
**RED OAK AND POPLAR**

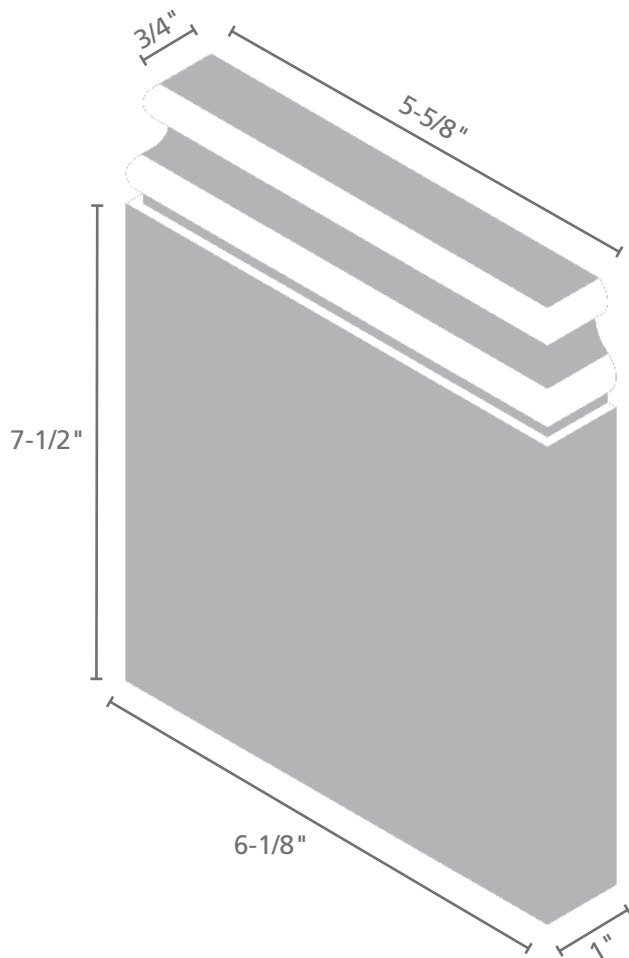
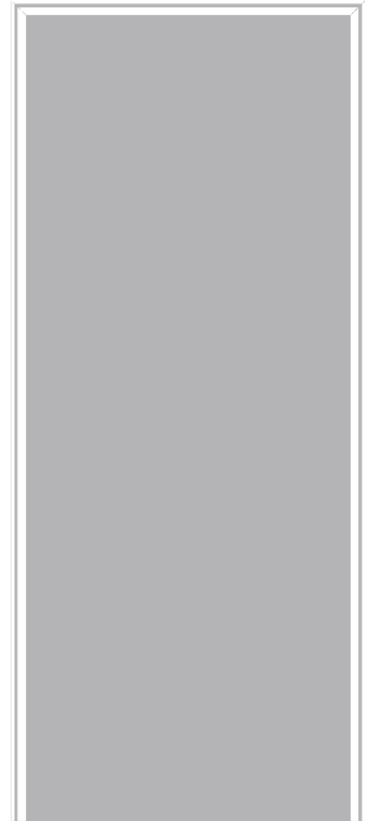

**HL6-2413**  
 4<sup>1</sup>/<sub>8</sub>" x 7<sup>1</sup>/<sub>2</sub>" for 3<sup>1</sup>/<sub>2</sub>" casing  
**POPLAR**

**HL6-2613**  
 6<sup>1</sup>/<sub>8</sub>" x 7<sup>1</sup>/<sub>2</sub>" for 5<sup>1</sup>/<sub>2</sub>" casing  
 (shown)  
**POPLAR**

**HL6-2788**  
 7<sup>7</sup>/<sub>8</sub>" x 12" for 7<sup>1</sup>/<sub>4</sub>" casing  
**POPLAR**

## DOOR STOP



HL4138M  
7/16" x 1 3/8"  
**RED OAK**  
AND **POPLAR**



HL4138  
7/16" x 1 3/8"  
**RED OAK**  
AND **POPLAR**



HL41383  
7/16" x 1 3/8"  
**RED OAK**  
AND **POPLAR**



HL41389  
7/16" x 1 3/8"  
**POPLAR**

## GLASS BEAD



HL9044  
1/2" x 7/16"  
**RED OAK**  
AND **POPLAR**



HL114 1/4" x 1 1/4"  
**RED OAK** AND **POPLAR**



HL158 1/4" x 1 5/8"  
**RED OAK** AND **POPLAR**



HL134 1/4" x 1 3/4"  
**RED OAK** AND **POPLAR**



HL250 1/4" x 2 1/2"  
**RED OAK** AND **POPLAR**

## DOOR JAMB



HL4456 1 1/16" x 4 5/8" **RED OAK** AND **POPLAR**  
 HL4481 1 1/16" x 4 7/8" **RED OAK** AND **POPLAR**  
 HL4525 1 1/16" x 5 1/4" **RED OAK** AND **POPLAR**  
 HL4656 1 1/16" x 6 5/8" **RED OAK** AND **POPLAR**

## CHAIR RAIL



HL5238  $\frac{3}{4}$ " x  $2\frac{3}{8}$ "  
RED OAK AND POPLAR



HL5275  $1\frac{1}{16}$ " x  $2\frac{3}{4}$ "  
RED OAK AND POPLAR



HL5238N  $\frac{3}{4}$ " x  $2\frac{3}{8}$ "  
RED OAK AND POPLAR



HL5300  $1\frac{1}{16}$ " x 3"  
RED OAK AND POPLAR



HL5325 1" x  $3\frac{1}{4}$ "  
RED OAK AND POPLAR



HL54251  $\frac{7}{16}$ " x  $4\frac{1}{4}$ " POPLAR



HL52752  $\frac{3}{4}$ " x  $2\frac{1}{2}$ " POPLAR

# NOSING



HL71251  
1/2" x 1 1/4"

**RED OAK  
AND  
POPLAR**



HL71501  
3/4" x 1 1/2"

**RED OAK  
AND  
POPLAR**



HL71252  
1 1/16" x 1 1/4"

**RED OAK  
AND  
POPLAR**



HL715017  
1 1/16" x 1 1/2"

**RED OAK  
AND  
POPLAR**



HL72004  
1" x 2"

**RED OAK  
AND  
POPLAR**

# HALF ROUND



HL7075  
3/8" x 3/4"

**RED OAK  
AND  
POPLAR**



HL9100  
1/2" x 1"

**RED OAK  
AND  
POPLAR**



HL9150  
3/4" x 1 1/2"

**RED OAK  
AND  
POPLAR**

# PANEL MOULD



HL90571  
7/16" x 9/16"  
POPLAR



HL90756  
industry #140  
1/4" x 3/4"  
RED OAK AND  
POPLAR



HL71002  
9/16" x 1"  
RED OAK AND  
POPLAR



HL71005  
1/2" x 3/4"  
POPLAR



HL7094  
1/2" x 15/16"  
POPLAR



HL7100  
7/16" x 1"  
RED OAK AND  
POPLAR



HL7125  
5/8" x 1 1/4"  
RED OAK AND  
POPLAR



HL710012  
7/16" x 1"  
POPLAR



HL7138  
3/8" x 1 3/8"  
POPLAR



HL716312  
1 1/16" x 1-5/8"  
POPLAR



HL72002 3/4" x 2"  
RED OAK AND  
POPLAR



HL7200 1" x 2"  
RED OAK AND  
POPLAR



HL71388  
3/4" x 1 3/8"  
POPLAR

# T&G BEADBOARD



HL9319 3/8" x 3 3/16" POPLAR

# PLANKING



HL93251-525 3/4" x 5 1/2" (5 1/4" Coverage) POPLAR



## BED MOULD



HL7125  
5/8" x 1 1/4"

RED OAK AND  
POPLAR



HL2125  
3/4" x 1 1/4"

RED OAK AND  
POPLAR



HL21254  
1 1/16" x 1 1/4"

POPLAR



HL21757  
1 3/16" x 1 3/4"

POPLAR

## MULLIONS



HL71253 3/8" x 1 1/4"  
POPLAR



HL72005 3/8" x 2"  
POPLAR



HL7250 3/8" x 2 1/2"  
POPLAR

## SCREEN BEAD



HL90755  
1/4" x 3/4"

RED OAK AND  
POPLAR

## CABINET MOULD



HL715013 3/4" x 1 1/2"  
POPLAR



HL907515 5/16" x 3/4"  
POPLAR

## WINDOW SILL



HL9250  $\frac{3}{4}$ " x  $2\frac{1}{2}$ "  
RED OAK AND POPLAR



HL92502  $\frac{3}{4}$ " x  $2\frac{1}{2}$ "  
RED OAK AND POPLAR



HL92508 1" x  $2\frac{1}{2}$ "  
RED OAK AND POPLAR



HL93503 1" x  $3\frac{1}{2}$ "  
RED OAK AND POPLAR



HL955010 1" x  $5\frac{1}{2}$ "  
RED OAK AND POPLAR

## ASTRAGAL



HL5-AST **SP**  
1 1/4" x 2"  
WM1305

## BASE



HL5 - 714 **SP** 9/16" x 3" 714



HL5 - 664 **SP** 9/16" x 3" WM664



HL5 - 623 **SP** 9/16" x 3 1/4" WM623

## BRICK MOULD



HL5 - 180 **SP**  
1 1/4" x 2" WM180

## CHAIR RAIL



HL5 - 390 **SP**  
1 1/16" x 2 5/8" WM390

## CASING



HL5 - 327 **SP**  
1 1/16" x 2 1/4" WM327



HL5 - 356 **SP**  
1 1/16" x 2 1/4" WM356

# CORNER GUARD



HL5-205 **SP** 1 1/8" x 1 1/8"  
WM205

# COVE



HL5-93 **SP** 3/4" x 3/4"  
WM93

# CROWN



HL5-48L **SP** 9/16" x 4 1/4" LWM48

# LATTICE



HL5 - 267 **SP**  
1/4" x 1 3/8" WM267



HL5 - 265 **SP**  
1/4" x 1 3/4" WM265

# FULL ROUND

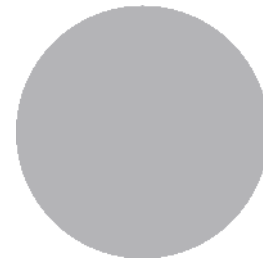

HL5 - 233H **SP**  
1 5/16" x 1 5/16"

## PARTING STOP



HL5 - 254  
**SP**  
1/2" x 3/4"  
WM254

## QUARTER ROUND



HL5 - 108  
**SP**  
1/2" x 1/2"  
WM108



HL5 - 106  
**SP**  
1 1/16" x 1 1/16"  
WM106

## SCREEN MOULD SHOE STOP



HL5 - 142  
**SP**  
1/4" x 3/4"  
WM142



HL5 - 126  
**SP**  
1/2" x 3/4"  
WM126



HL5 - 936  
**SP**  
7/16" x 1 3/8"  
WM936



HL5 - 846HL  
**SP**  
7/16" x 1 3/8"  
WM846



HL5 - 906F07  
**SP**  
7/16" x 1 3/8"  
WM906

## WALL RAIL / HAND RAIL



HL5 - 240H **Hemlock**  
1 3/16" x 2 1/4"  
WM240



HL5 - 230LH **Hemlock**  
1 1/4" x 2"  
WM230

## BASE



HL4 - 623J **PFJ**  $\frac{9}{16}$ " x  $3\frac{1}{4}$ " WM623



HL4 - 663P **PFJ**  $\frac{9}{16}$ " x  $3\frac{1}{4}$ "



HL4 - 2808J **PFJ**  $\frac{9}{16}$ " x  $4\frac{1}{4}$ "



HL4 - 163ESP **PFJ**  $\frac{9}{16}$ " x  $5\frac{1}{4}$ "



HL4 - 2813J **PFJ**  $\frac{9}{16}$ " x  $5\frac{1}{4}$ "

## CASING



HL4 - 356P **PFJ**  
1<sup>1</sup>/<sub>16</sub>" x 2<sup>1</sup>/<sub>4</sub>" WM356



HL4 - 361P **PFJ**  
1<sup>1</sup>/<sub>16</sub>" x 2<sup>1</sup>/<sub>2</sub>" 361P



HL4 - 2488CAJ **PFJ**  
1<sup>1</sup>/<sub>16</sub>" x 2<sup>3</sup>/<sub>4</sub>"



HL4 - 444LJ **PFJ** 1<sup>1</sup>/<sub>16</sub>" x 3<sup>1</sup>/<sub>4</sub>"



HL4 - 24112CAJ **PFJ** 1<sup>1</sup>/<sub>16</sub>" x 3<sup>1</sup>/<sub>2</sub>"

## BRICK MOULD



HL4 - 180PF17 **PFJ**  
1<sup>1</sup>/<sub>4</sub>" x 2" WM180

## CHAIR RAIL



HL4 - 390J **PFJ**  
1<sup>1</sup>/<sub>16</sub>" x 2<sup>5</sup>/<sub>8</sub>" WM390

### CROWN



HL4 - 48LJ **PFJ** 9/16" x 4 1/4" LWM48

### STOP



HL4 - 947P  
**PFJ**  
3/8" x 1 1/4"  
WM947



HL4 - 906PF07  
**PFJ**  
3/8" x 1 1/4"  
WM906



HL4 - 876PF07  
**PFJ**  
7/16" x 1 3/8"  
WM876

### BASE CAP



HL3 - 163M  
**PFJ**  
9/16" x 1 7/16"



HL4 - 166P  
**PFJ**  
5/8" x 1 1/4"

### SHOE



HL4 - 126P  
**PFJ**  
1/2" x 3/4"  
WM126



HL4 - L254  
**PFJ**  
7/16" x 3/4"  
WM126



# EASED EDGE S4S

Note: For Stock Square Edge S4S, please see page 2.



HL3 - 14E2EM **MDF** 1<sup>1</sup>/<sub>16</sub>" x 3<sup>1</sup>/<sub>2</sub>"



HL3 - 430LM **MDF** 9<sup>9</sup>/<sub>16</sub>" x 5<sup>1</sup>/<sub>2</sub>"



HL3 - 16E2EM **MDF** 1<sup>1</sup>/<sub>16</sub>" x 5<sup>1</sup>/<sub>2</sub>"

# BASE



HL3-623M  
**MDF**  
1/2" x 3 1/4"  
623M

HL3-663M  
**MDF**  
1/2" x 3 1/4"  
663M

HL3-620LM  
**MDF**  
1/2" x 4 1/4"  
620LM

HL3-412M  
**MDF**  
5/8" x 4 1/4"  
412M

HL3-808M  
**MDF**  
1/2" x 4 1/4"  
808M

HL3-20136CBM  
**MDF**  
9/16" x 4 1/4"  
20136CBM

H O L M E S L U M B E R C O M P A N Y

MEDIUM DENSITY FIBERBOARD (MDF)

# MEDIUM DENSITY FIBERBOARD (MDF)

H O L M E S L U M B E R C O M P A N Y

## BASE



**HL3-545M**  
**MDF**  
5/8" x 5"  
545M

**HL3 - 813M**  
**MDF**  
1/2" x 5 1/4"

**HL3 - 618M**  
**MDF**  
1/2" x 5 1/4"

**HL3-163EM**  
**MDF**  
9/16" x 5 1/4"  
163EM

**HL3-207M**  
**MDF**  
9/16" x 7 1/4"  
207M

**HL3-163E7M**  
**MDF**  
9/16" x 7 1/4"  
163E7M

# CASING



HL3 - 356M **MDF**  $\frac{9}{16}$ " x  $2\frac{1}{4}$ " 356M



HL3 - 2488CAM **MDF**  $\frac{3}{4}$ " x  $2\frac{3}{4}$ "



HL3 - 411M **MDF**  $\frac{3}{4}$ " x 3" 411M



HL3 - 445LM **MDF**  $1\frac{1}{16}$ " x  $3\frac{1}{4}$ " 445LM



HL3 - 421M **MDF**  $1\frac{1}{16}$ " x  $3\frac{1}{4}$ "



HL3 - 444LM **MDF**  $1\frac{1}{16}$ " x  $3\frac{1}{4}$ "



HL3 - 523M **MDF** 1" x  $3\frac{1}{2}$ " 523M

## CASING

HL3 - 24112PCAM **MDF** 1<sup>1</sup>/<sub>16</sub>" x 3<sup>1</sup>/<sub>2</sub>" 24112PCAMHL3 - 535M **MDF** 3<sup>3</sup>/<sub>4</sub>" x 3<sup>1</sup>/<sub>2</sub>" 535MHL3 - 444M **MDF** 1<sup>1</sup>/<sub>16</sub>" x 3<sup>1</sup>/<sub>2</sub>" 444MHL3 - 99M **MDF** 1<sup>1</sup>/<sub>16</sub>" x 3<sup>1</sup>/<sub>2</sub>" 99MHL3 - 445M **MDF** 9<sup>9</sup>/<sub>16</sub>" x 3<sup>1</sup>/<sub>4</sub>" 445M

# MEDIUM DENSITY FIBERBOARD (MDF)

H O L M E S L U M B E R C O M P A N Y

## CROWN



HL3 - 49M **MDF**  $\frac{9}{16}$ " x  $3\frac{5}{8}$ " 49M



HL3 - 48LM **MDF**  $\frac{5}{8}$ " x  $4\frac{1}{4}$ " 48LM

# MEDIUM DENSITY FIBERBOARD (MDF)

H O L M E S L U M B E R C O M P A N Y

## CROWN



HL3 - 47M **MDF** 9/16" x 4 5/8" 47M

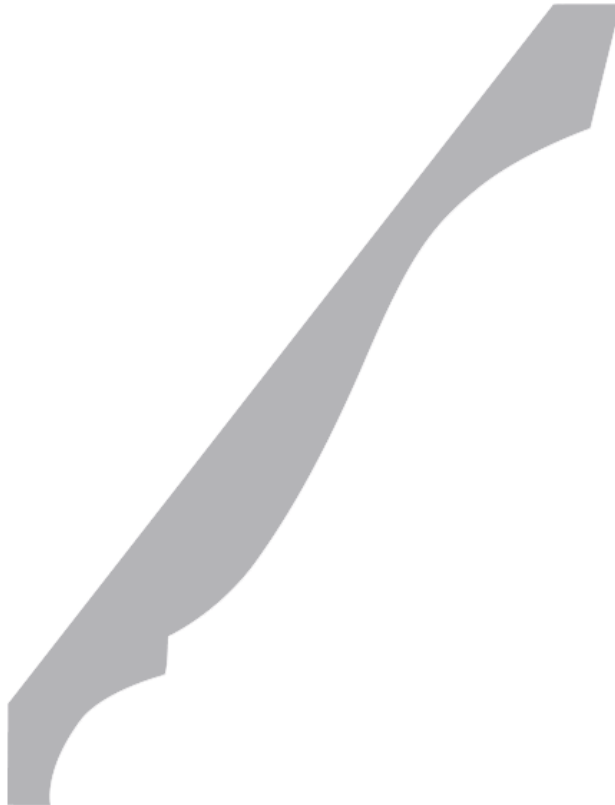

HL3 - 45M **MDF** 9/16" x 5 1/4" LWM45

# MEDIUM DENSITY FIBERBOARD (MDF)

H O L M E S L U M B E R C O M P A N Y

## CROWN



HL3 - 2153M **MDF**  $\frac{3}{4}'' \times 5\frac{1}{4}''$



HL3 - 43M **MDF**  $\frac{15}{16}'' \times 6\frac{15}{16}''$

# CHAIR RAIL



HL3 - 390LM **MDF** 1 1/16" x 2 7/16" LWM390



HL3 - 297M **MDF** 9/16" x 3" WM297

# TONGUE AND GROOVE SHIP LAP

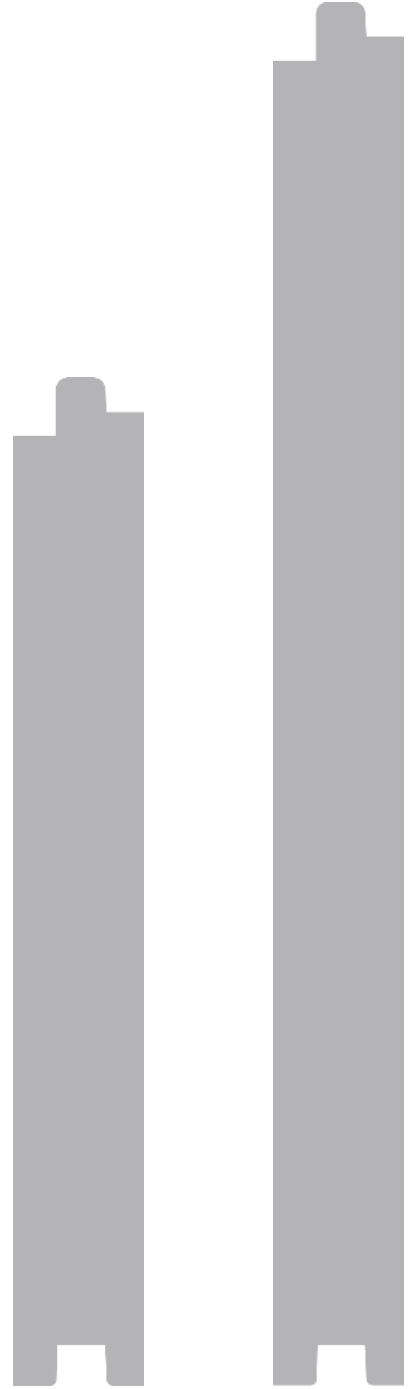

HL3 - SL16  
**MDF**  
1 1/16" x 5 1/4"

HL3 - SL18  
**MDF**  
1 1/16" x 7 1/4"



## CASING



HL IMP - 1225 **IMPERIAL OAK**  $\frac{7}{16}'' \times 2\frac{1}{4}''$

## BASE



HL IMP - 2300 **IMPERIAL OAK**  $\frac{5}{16}'' \times 2\frac{3}{4}''$

## SHOE



HL IMP - 2050 **IMPERIAL OAK**  $\frac{1}{2}'' \times \frac{3}{4}''$

## JAMB



HL IMP - 445668 **IMPERIAL OAK**  $1\frac{1}{16}'' \times 4\frac{9}{16}''$  (Knotted Jamb Leg)

## STOP



HL IMP - 4138-7 **IMPERIAL OAK**  $\frac{3}{8}'' \times 1\frac{1}{4}''$  (7' Leg)



# Your Complete Building Supply Source

## RESIDENTIAL

Supplying material for quality homes from start to finish



## POST FRAME

We are Ohio's premier post frame material supplier



## COMMERCIAL

We're prepared to help you with any of your larger projects such as:

- Hotels · Restaurants
- Office Buildings
- Multi-Family Units
- Assisted Living Facilities



## RETAIL HARDWARE

For the pro-contractor and the do-it-yourself customer



## DELIVERY

We deliver what you need, when you need it, and where you need it



## INTERIOR TRIM & DOORS

Skilled craftsmen to pre-hang your interior doors



## CUSTOM MILLWORK

Need something more than the ordinary? We'll manufacture it



## INTERIOR TRIM DELIVERIES

Our demountable trim trucks make loading a snap



## ESTIMATING

Determining the right amount of materials, saves you time and money



## DRAFTING

Behind every beautiful building, there's a "plan"



## PRE-BUILT STAIRWAYS

Every stairway is custom built to your specifications



## OVERHEAD GARAGE DOORS

Professional garage door installation



## DESIGN CENTER

The Gallery of Home Décor Choices



## KITCHEN & BATH

Knowledge and creativity with experience



**Holmes Lumber**   
The Lumberyard For Professionals

**Millersburg**  
330-674-9060  
**Sugarcreek**  
330-852-4611

**Dover**  
330-343-7737  
**Canton**  
330-479-8314

**Marion**  
740-382-5729  
**Dublin**  
614-873-4411

**Reynoldsburg**  
740-927-3700  
**Sunbury**  
740-965-4600

**Lancaster**  
740-654-7611  
**Newark**  
740-366-7308

[holmeslumber.com](http://holmeslumber.com)

# Your Full Service Lumberyard

These are a few of the quality brands in our broad inventory of product lines.



# Holmes Lumber

*The Lumberyard For Professionals*



[holmeslumber.com](http://holmeslumber.com)

A Division of the Carter Lumber Company